

# Rim<sup>®</sup>

NÁVOD K POUŽITÍ  
BEDIENUNGSANLEITUNG  
OPERATING INSTRUCTIONS  
MODE D'EMPLOI  
INSTRUKCJA UŻYTKOWANIA  
HASZNÁLATI ÚTMUTATÓ

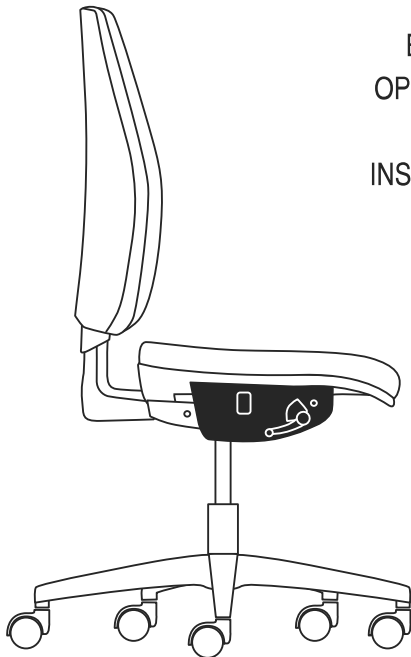

## **SYNCHRO ST1**

FLEXi FX 1104  
FLEXi FX 1114  
FOCUS FO 642C  
ANATOM AT 985A  
ACTIVE AC 954A  
NET NT 676A  
EASY PRO EP 1204  
ADAPT AD 971A

1

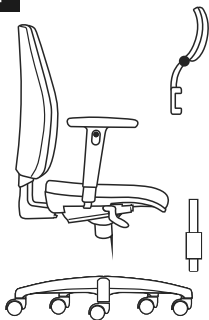

2

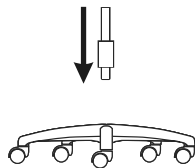

3

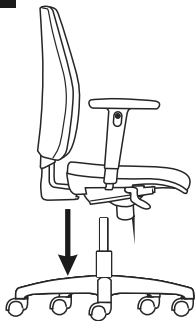

4

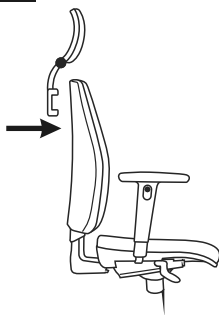

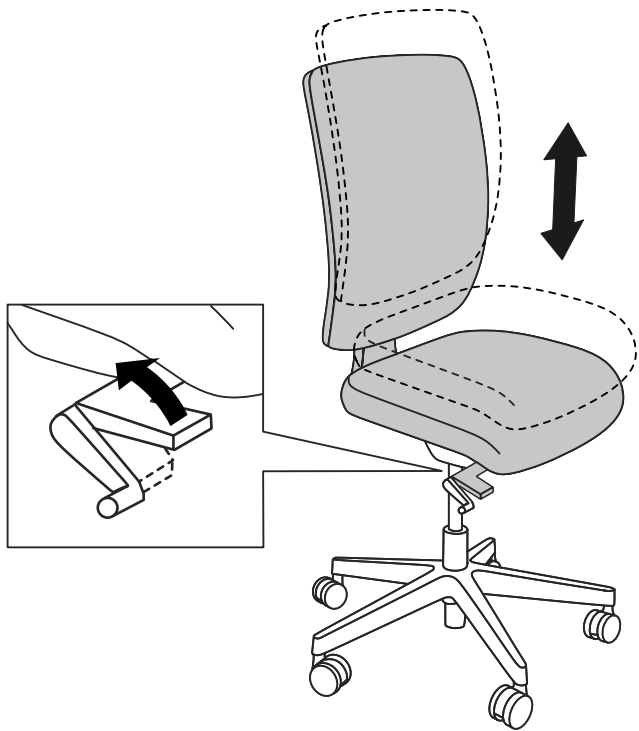

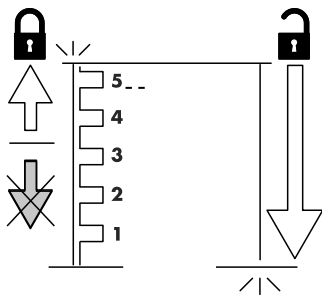
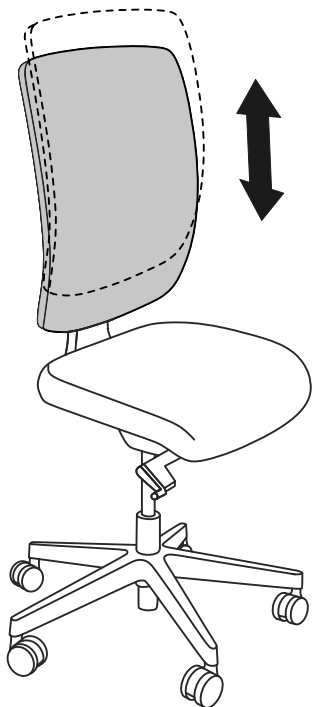

FLEXi FX 1104  
FLEXi FX 1114  
FOCUS FO 642C  
ANATOM AT 985A  
ACTIVE AC 954A  
ADAPT AD 971A

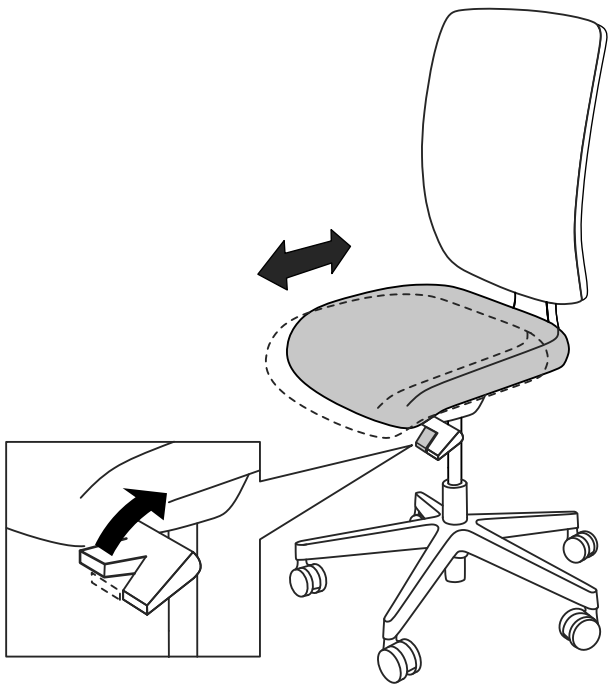

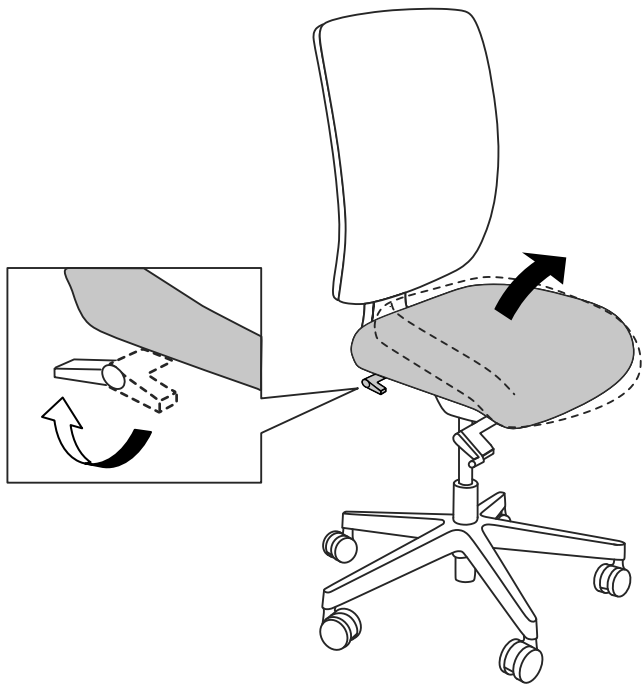

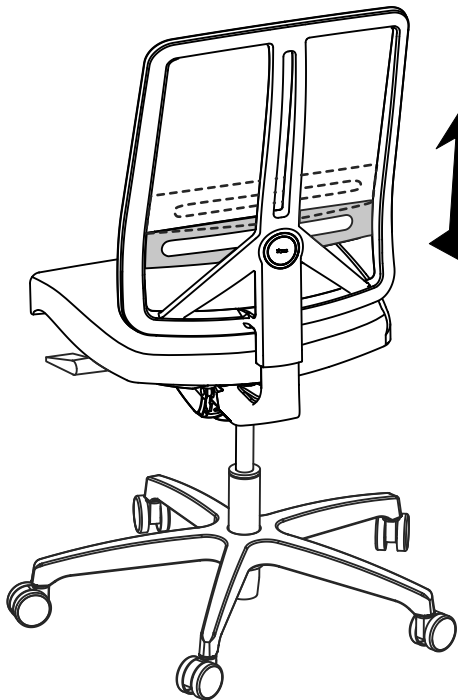

FLEXi FX 1104  
NET NT 676A  
EASY PRO EP 1204  
ADAPT AD 971A

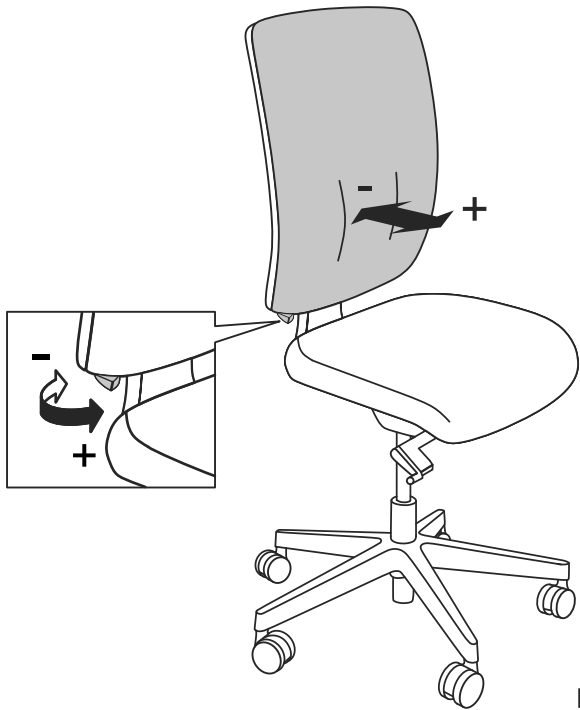

FLEXI FX 1114



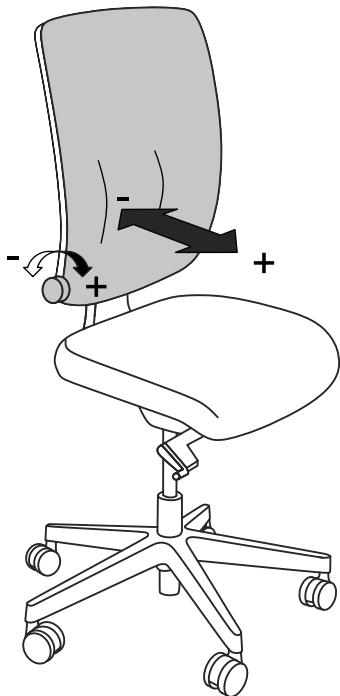

ANATOM AT 985A  
ACTIVE AC 954A

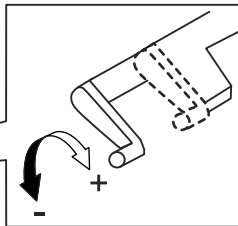
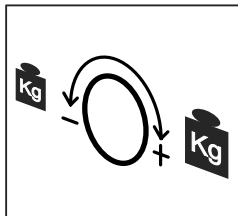
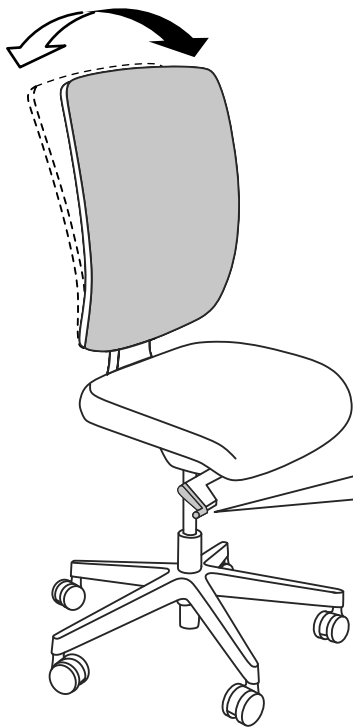

**STOP!**  
**STOP!**

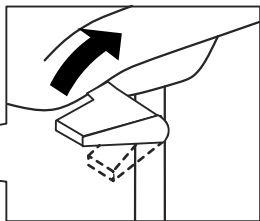
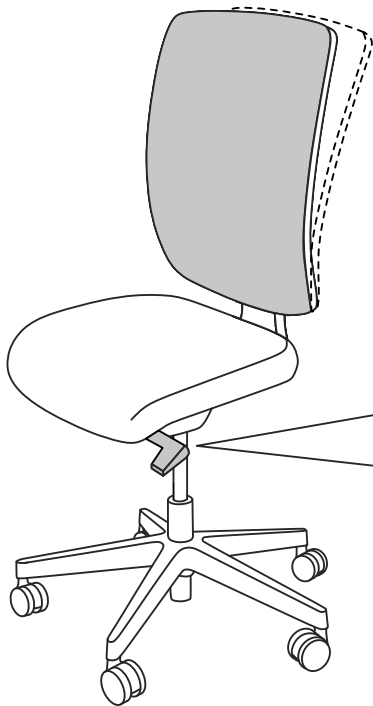

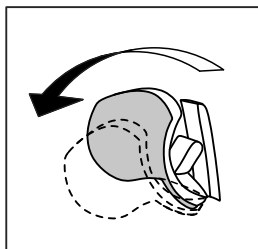
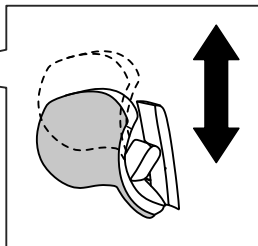
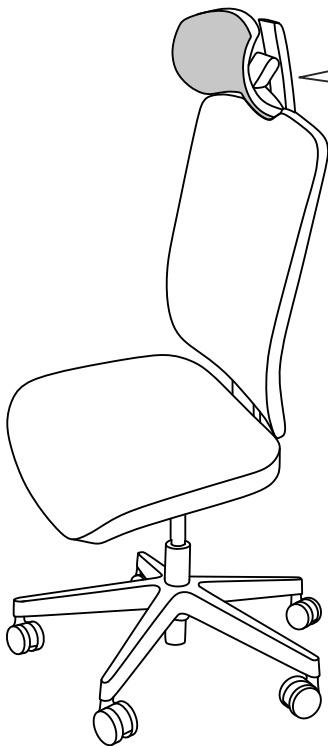

FLEXi FX 1104  
FLEXi FX 1114  
NET NT 676A

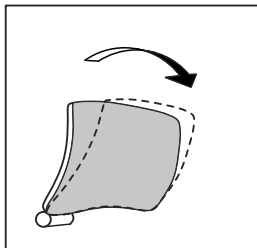
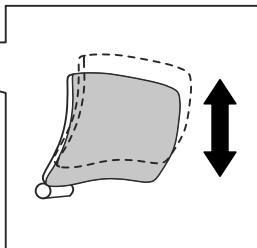
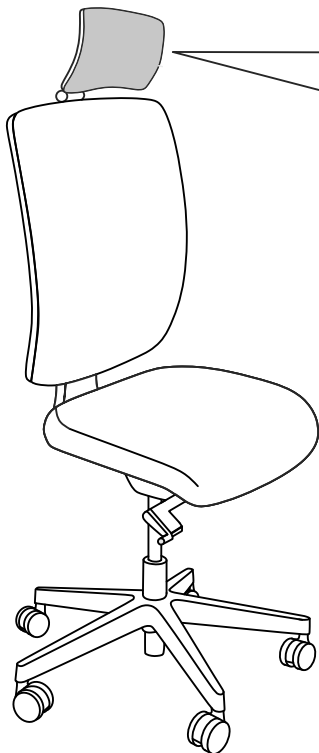

FOCUS FO 642C  
ANATOM AT 985A  
ACTIVE AC 954A  
ADAPT AD 971A

FLEXI FX 1104  
FLEXI FX 1114  
FOCUS FO 642C  
ANATOM AT 985A  
NET NT 676A  
EASY PRO EP 1204  
ADAPT AD 971A

82 1F

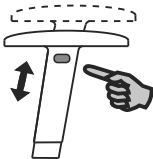

83 3F

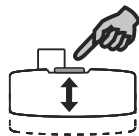
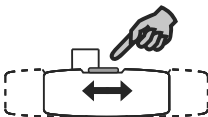
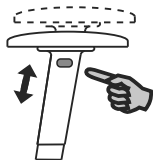

ACTIVE AC 954A

91 1F

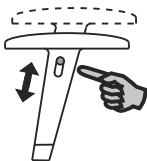

99 2F

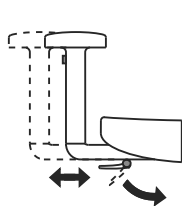
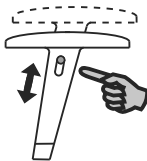

86 3F

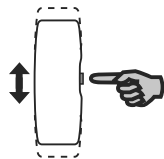
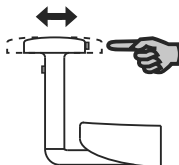
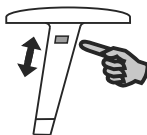

88 4F

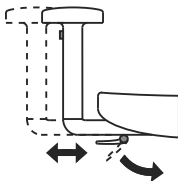
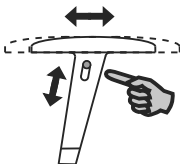

# Rim<sup>®</sup>

**RIM-CZ spol. s r.o.**

Dr. E. Beneše 1015

765 02 Otrokovice

CZECH REPUBLIC

Tel.: +420 577 112 641, -640

Fax: +420 577 101 015

E-mail: [info@rim.cz](mailto:info@rim.cz)

[www.rim.cz](http://www.rim.cz)

