

Rim[®]

NÁVOD K POUŽITÍ
BEDIENUNGSANLEITUNG
OPERATING INSTRUCTIONS
MODE D'EMPLOI
INSTRUKCJA UŻYTKOWANIA
HASZNÁLATI ÚTMUTATÓ

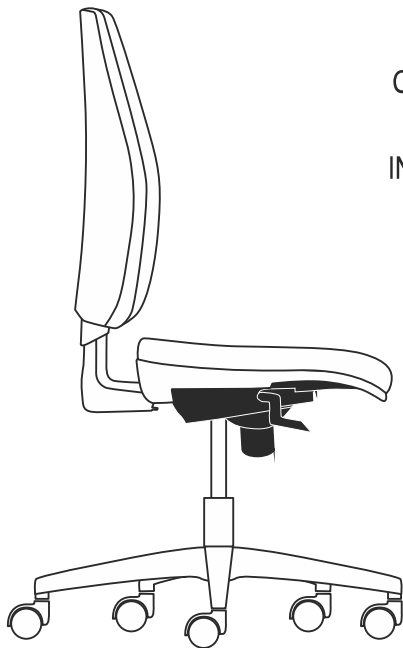

ANATOM AT 986B
EASY PRO EP 1207
FOCUS FO 641F
ZET ZE 916B
ZET ZE 919A

SYNCHRO ST5

1

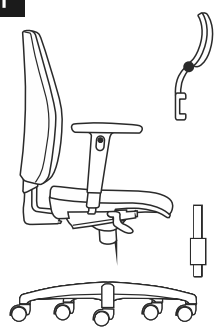

2

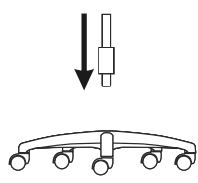

3

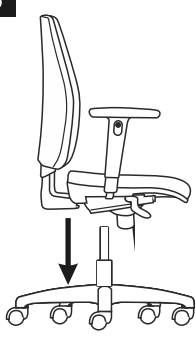

4

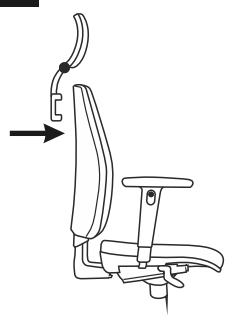

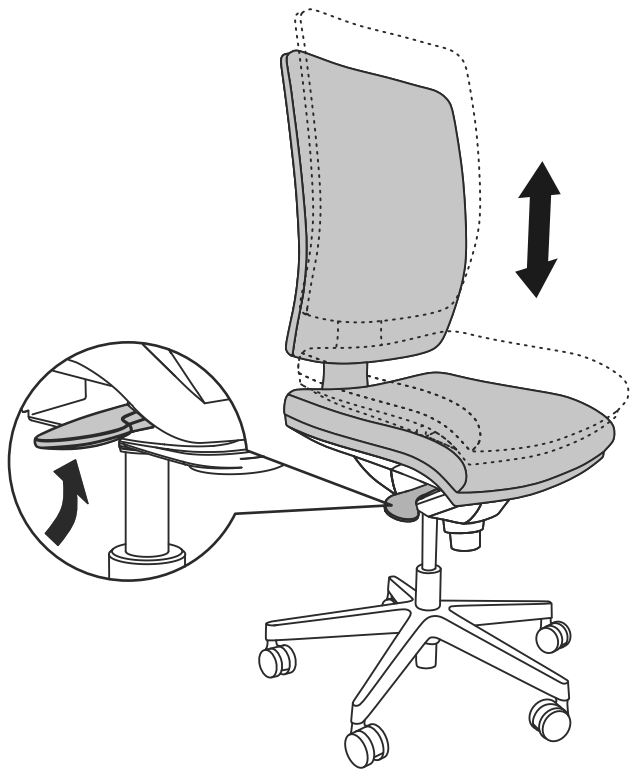

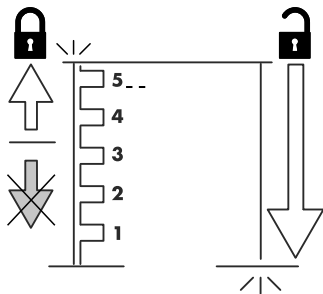
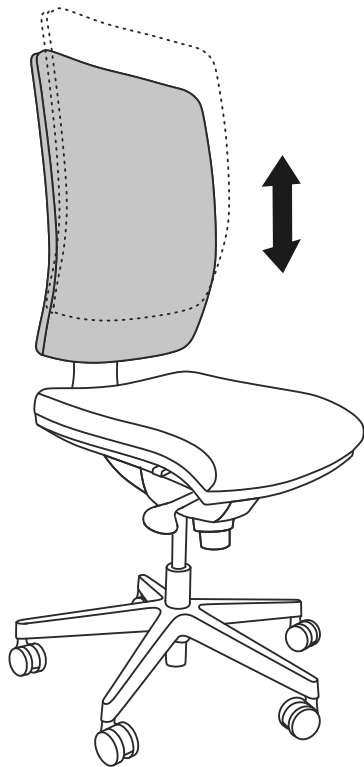

ANATOM AT 986B
FOCUS FO 641F
ZET ZE 916B
ZET ZE 919A

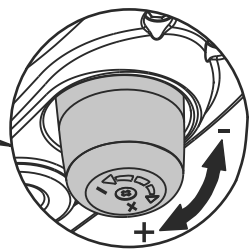
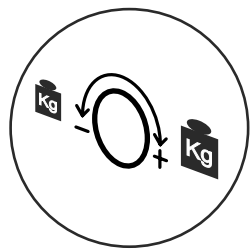
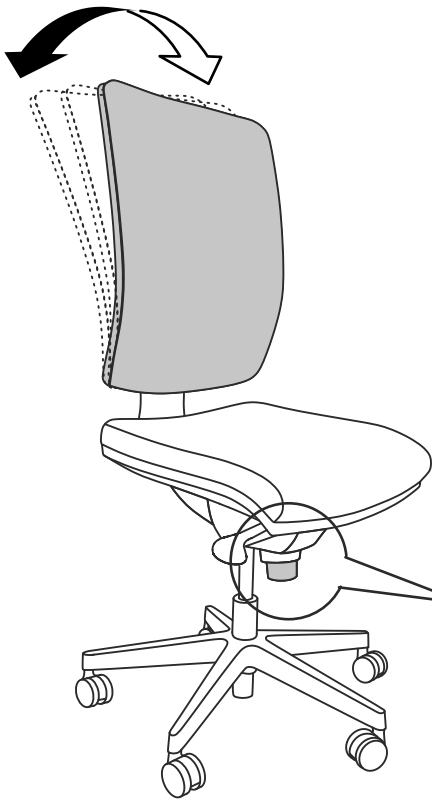

STOP!
STOP!

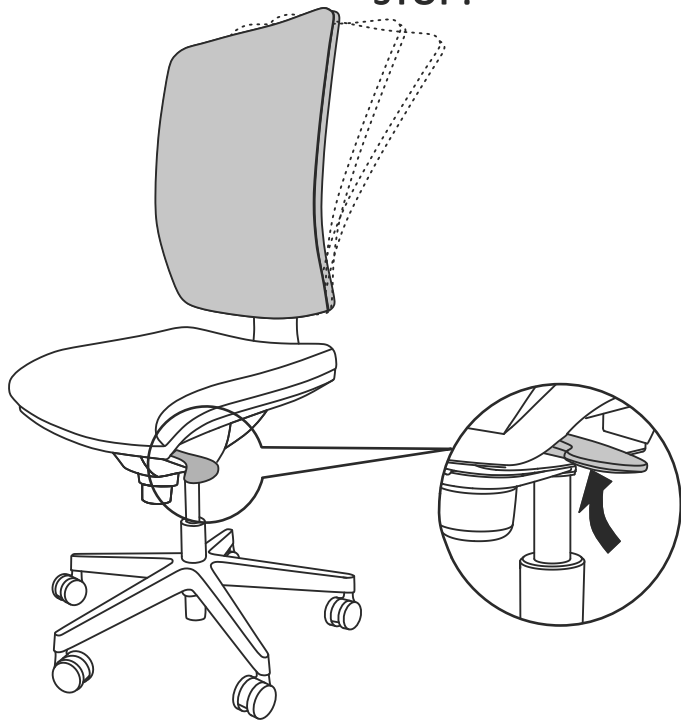

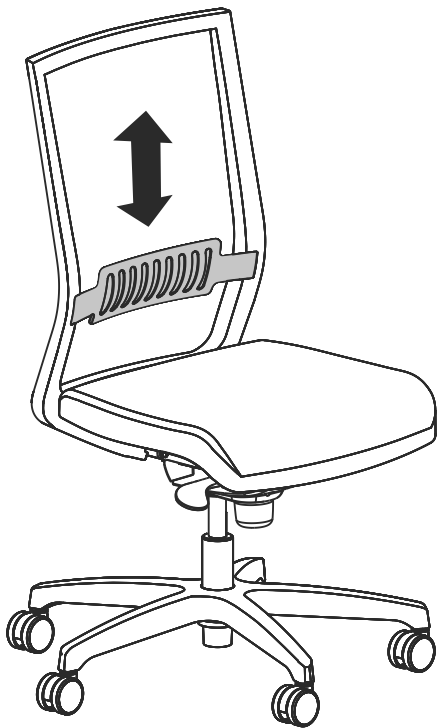

EASY PRO EP 1207

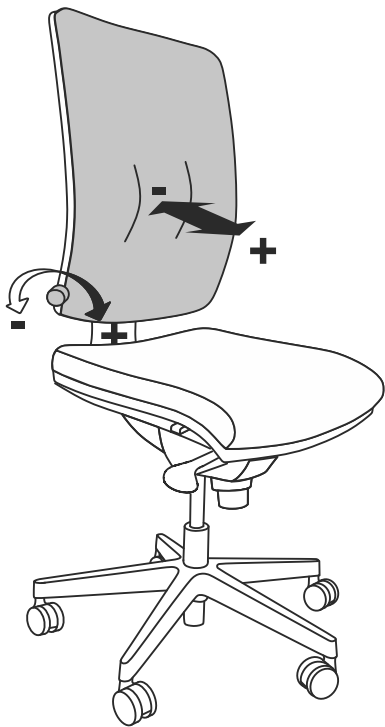

ANATOM AT 986B
ZET ZE 919A

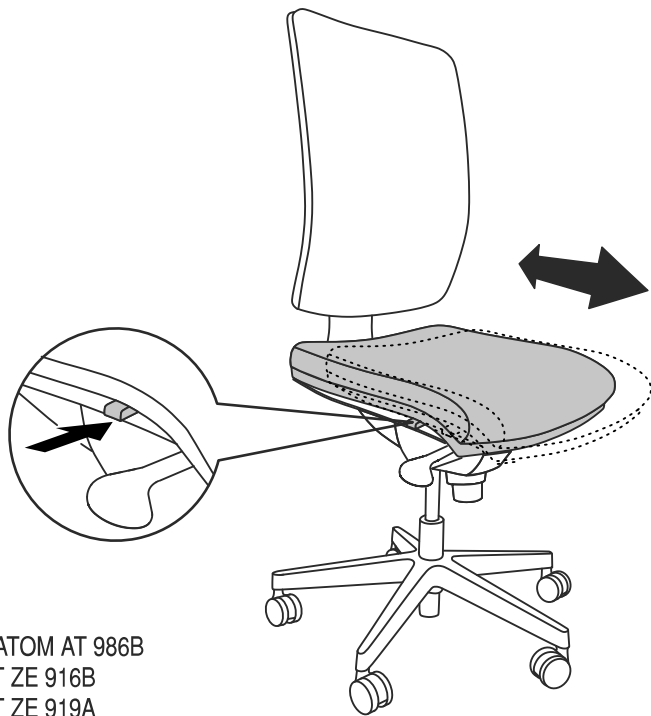

ANATOM AT 986B
ZET ZE 916B
ZET ZE 919A

ANATOM AT 986B
EASY PRO EP 1207
FOCUS FO 641F
ZET ZE 916B
ZET ZE 919A

082 1F

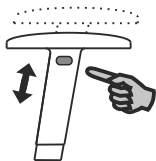

083A 3F

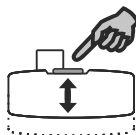
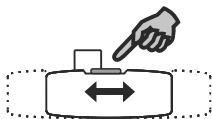
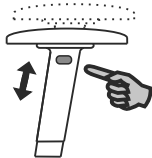

EASY PRO EP 1207
FOCUS FO 641F

084 4F

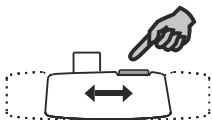
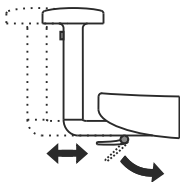
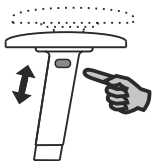

Rim[®]

RIM CZ s.r.o.

Dr. E. Beneše 1015

765 02 Otrokovice

CZECH REPUBLIC

Tel.: +420 577 112 641, -640

Fax: +420 577 101 015

E-mail: info@rim.cz

www.rim.cz

