

Rim

NÁVOD K POUŽITÍ
BEDIENUNGSANLEITUNG
OPERATING INSTRUCTIONS
MODE D'EMPLOI
INSTRUKCJA UŻYTKOWANIA
HASZNÁLATI ÚTMUTATÓ

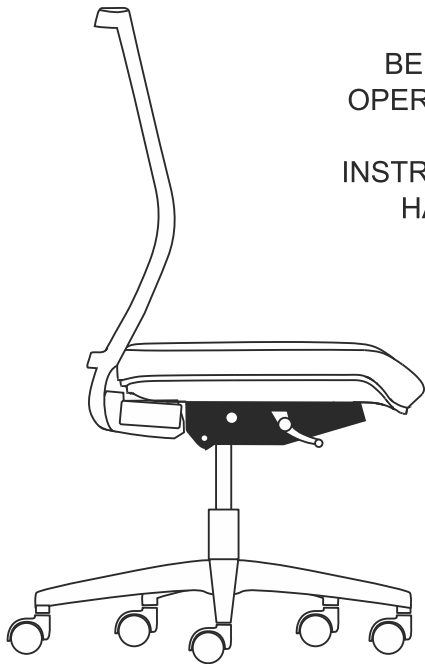

EASY PRO EP 1204
EASY PRO EP 1204L
FOCUS FO 642C
ANATOM AT 985A

ST1

1

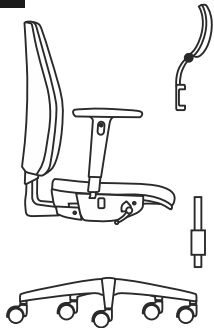

2

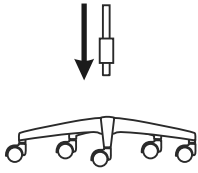

3

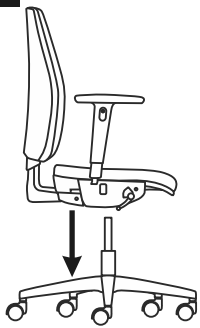

4

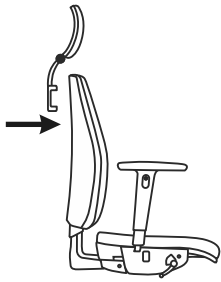

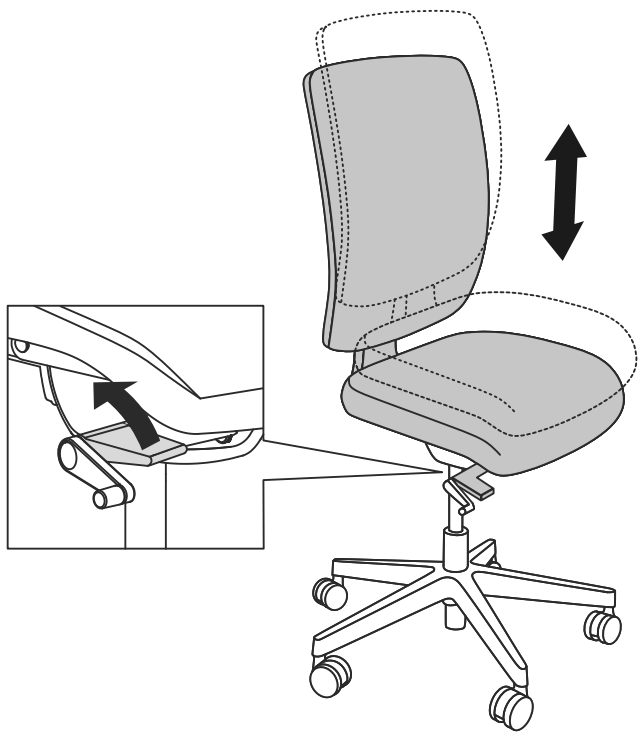

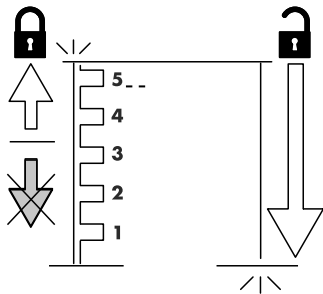
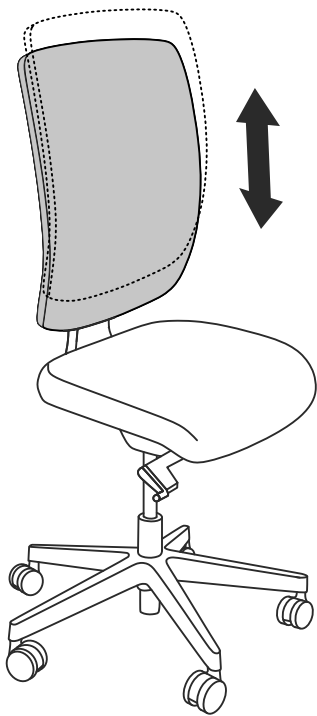

FOCUS FO 642C
ANATOM AT 985A

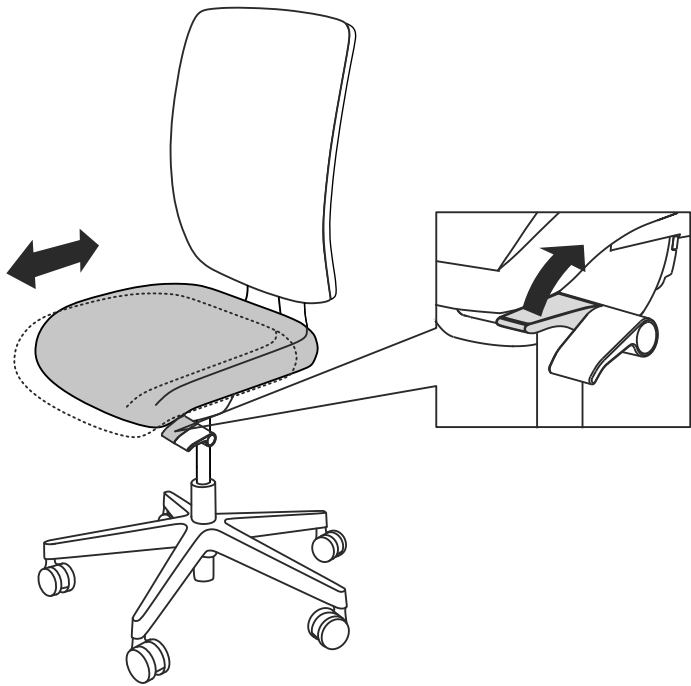

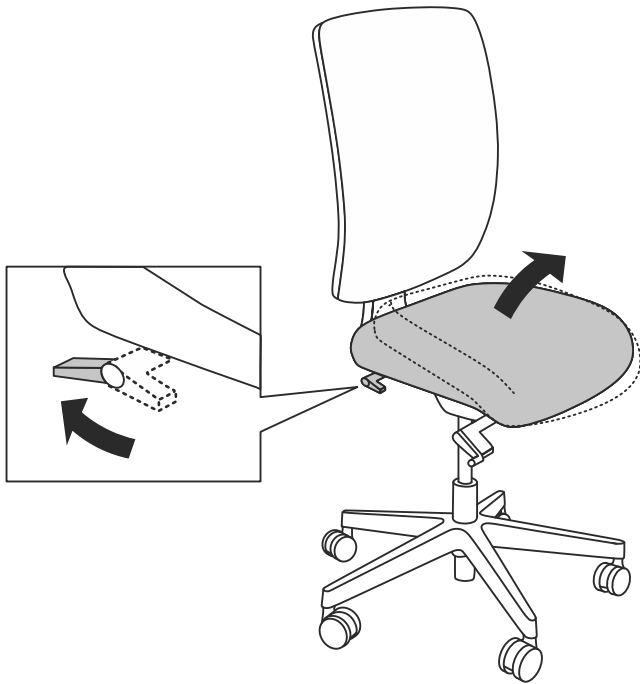

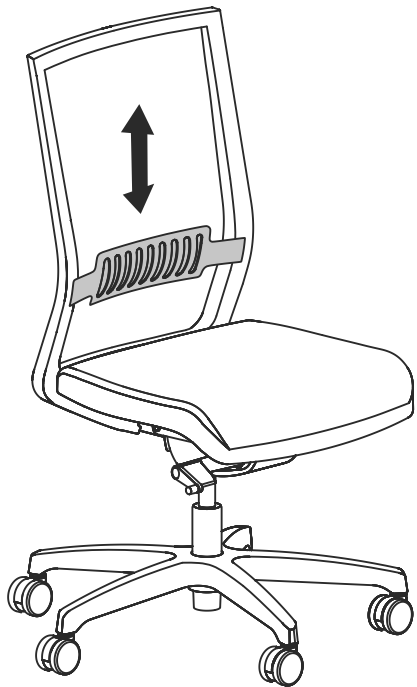

EASY PRO EP 1204
EASY PRO EP 1204L

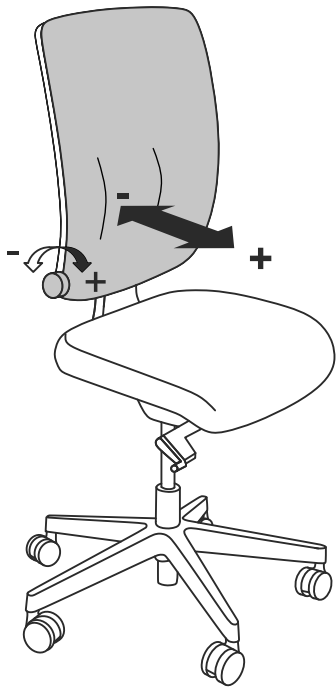

ANATOM AT 985A

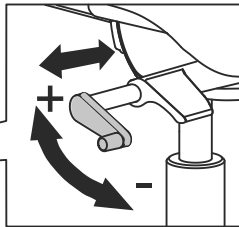
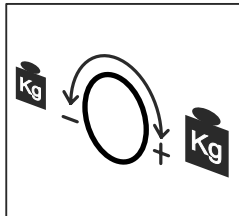
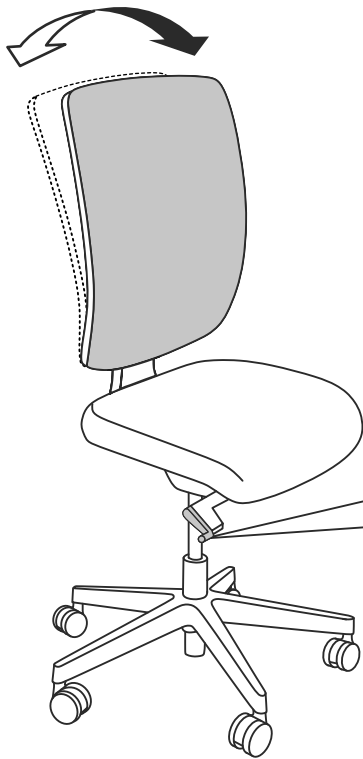

**STOP!
STOP!**

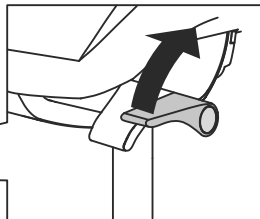
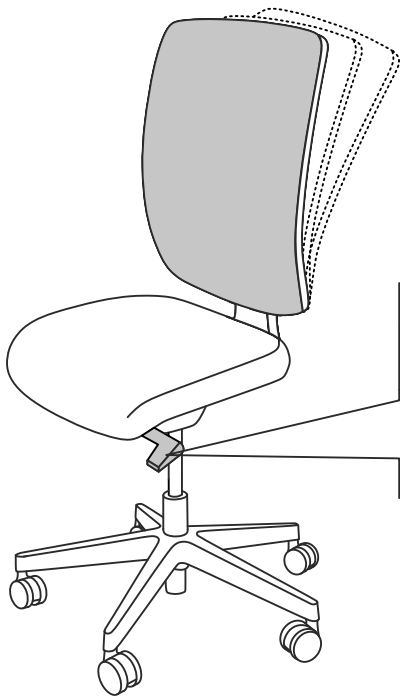

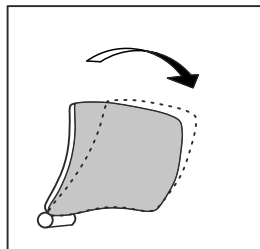
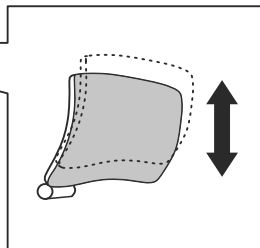
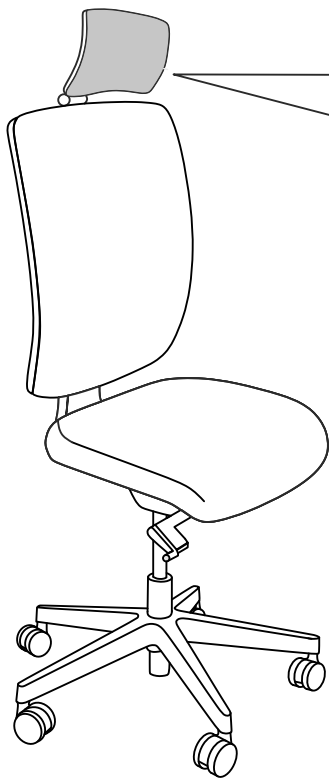

FOCUS FO 642C
ANATOM AT 985A

EASY PRO EP 1204
EASY PRO EP 1204L
FOCUS FO 642C

082 1F

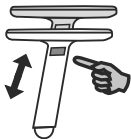

083A 3F

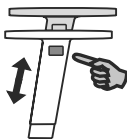

084 4F

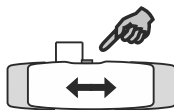
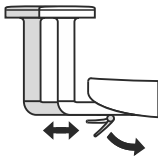
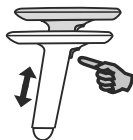

ANATOM AT 985A

082 1F

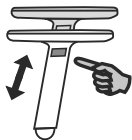

083A 3F

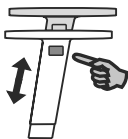

Rim

RIM CZ a.s.

Dr. E. Beneše 1015
765 02 Otrokovice
CZECH REPUBLIC

Tel.: +420 577 112 640

E-mail: info@rim.cz

www.rim.cz

